



PUNTA COMPONENTE PER FORATRICI MULTIPLE PER FORI PASSANTI

Throughbore doweldrill for multi-boringmachines

Durchgangsbohrer

Broca componibile para taladradoras múltiple - Taladros pasantes

D mm	Lu mm	Lt mm	ATTACCO - SHANK		Z	CODICE DX CODE RH	CODICE SX CODE LH
			d mm	l mm			
5	30	55,5	8	20	2	FPH02301	FPH02311
5	40	67	8	20	2	FPH02302	FPH02312
6	30	55,5	8	20	2	FPH02303	FPH02313
6	40	67	8	20	2	FPH02304	FPH02314
8	30	55,5	8	20	2	FPH02305	FPH02315
8	40	67	8	20	2	FPH02306	FPH02316
10	30	55,5	8	20	2	FPH02307	FPH02317
10	40	67	8	20	2	FPH02308	FPH02318
12	30	55,5	8	20	2	FPH02309	FPH02319
12	40	67	8	20	2	FPH02310	FPH02320

■ A richiesta si eseguono anche altre misure
Other dimension available on request

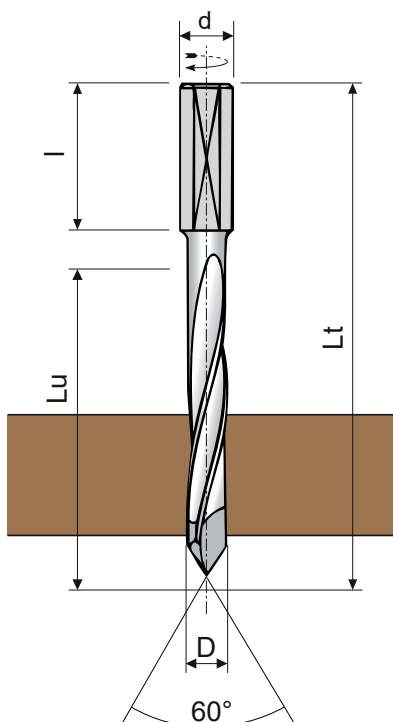

Forante in HW
HW drilling bit
HW Einbohrschneide
Placa de HW para taladrar

